

## TENDA A RULLO CASSONATA

**cassonetto 71x70**  
**movimentazione**  
**catena**

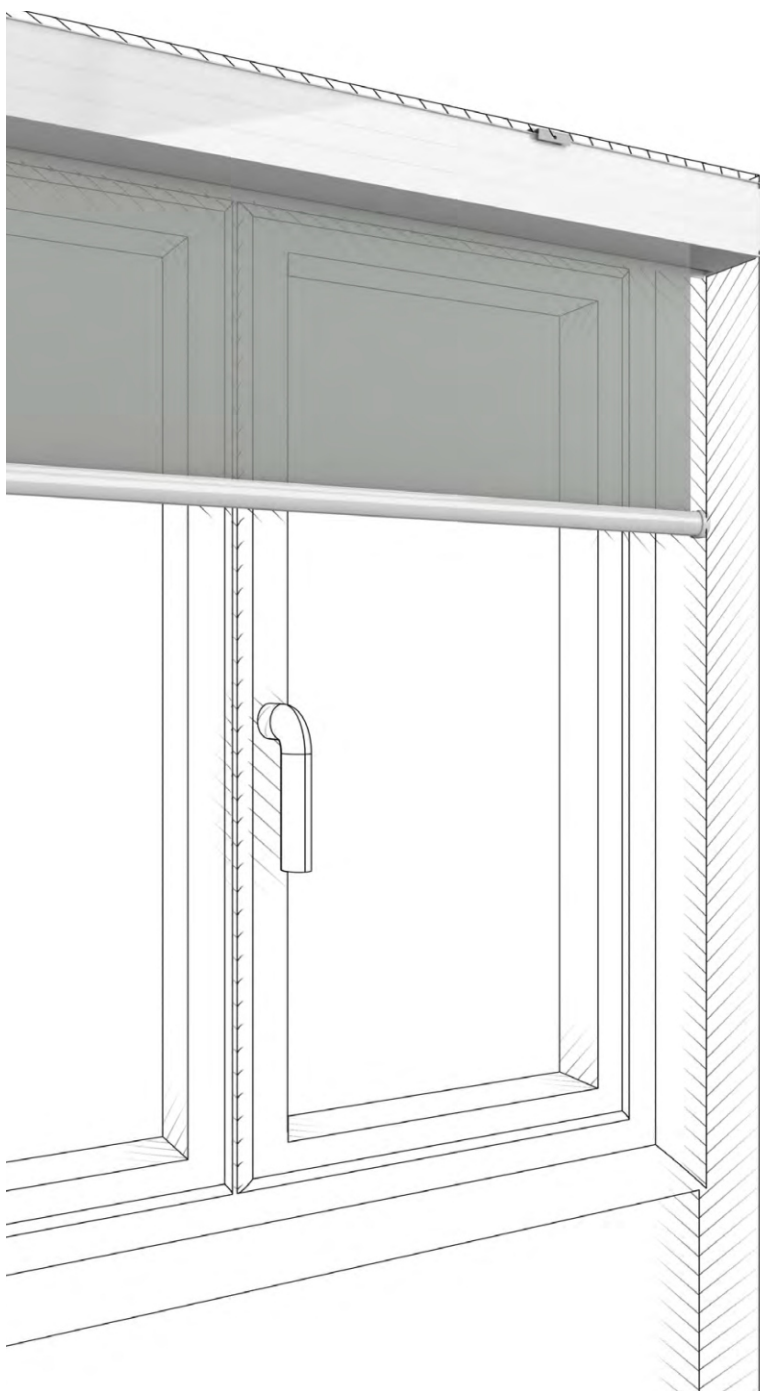

## Componenti

<b>AVVOLGITORE</b>	MATERIALE	Tubo di alluminio estruso con ogiva
<b>CASSONETTO</b>	MATERIALE	Alluminio estruso verniciato a polveri
	ISPEZIONABILE	No
	COMPLEMENTI	Guarnizione a spazzola
<b>FONDALE</b>	MATERIALE	Alluminio estruso verniciato a polveri
	COMPLEMENTI	Guarnizione a palloncino e zavorra in acciaio zincato
<b>GUIDE</b>	MATERIALE	Alluminio estruso verniciato a polveri
<b>VITERIA</b>	MATERIALE	Acciaio
<b>MANOVRE</b>	CATENA	Frizionata in plastica
<b>SUPPORTI</b>	FINITURA	Acciaio
<b>TIPI DI INSTALLAZIONE</b>		A soffitto con supporti / A parete con staffe frontali
<b>INSTALLAZIONE GUIDE</b>		Frontale / In luce
<b>DIMENSIONI</b>	LARGHEZZA (mm)	600 min - 2200 max
	ALTEZZA	In funzione del telo
<b>CONFEZIONE TELO</b>		Bottoni in plastica
		Steccature in acciaio
		Inserito al tubo mediante tondino
		Inserito al fondale mediante tondino

## Ingombri tecnici

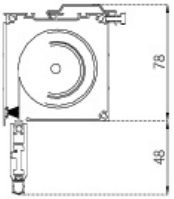

Fondale 11x41  
(rullo guidata)

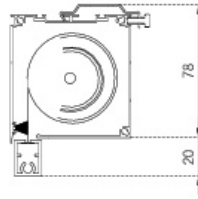

Fondale 15x20

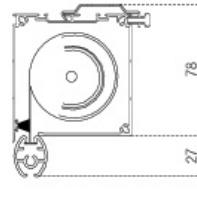

Fondale 19x23

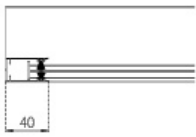

Guida 22x40

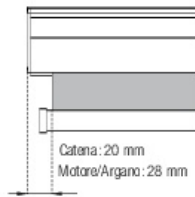

Tolleranza laterale del tessuto: catena 20mm

## Modalità d'installazione

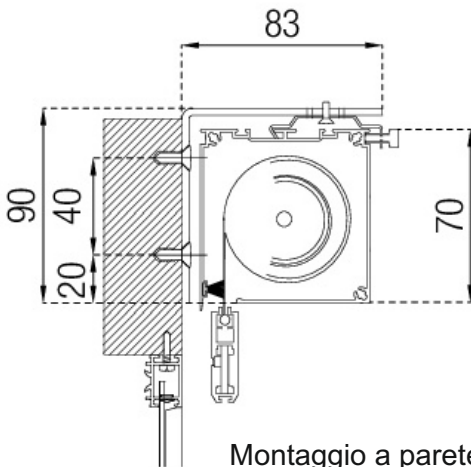

Montaggio a parete con staffa

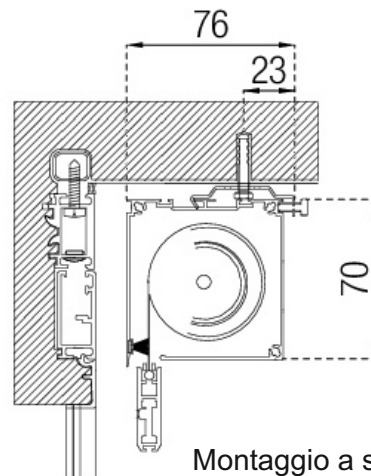

Montaggio a soffitto con supporto

## Configurazioni



Libera

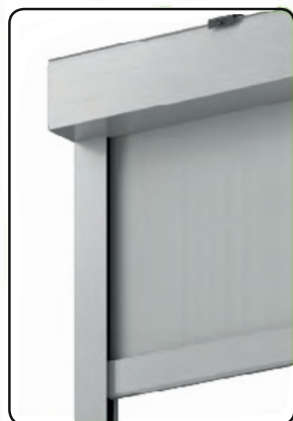

Guida 22x40

## Cassonetto

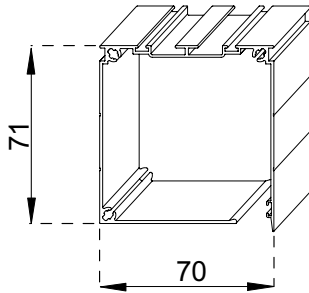

## Fondali

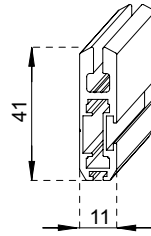

11x41  
(rullo guidata)

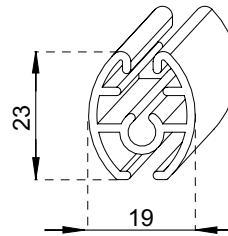

19x23

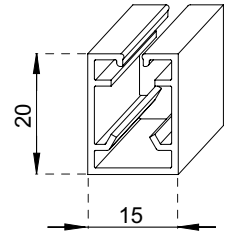

15x20

## Guide

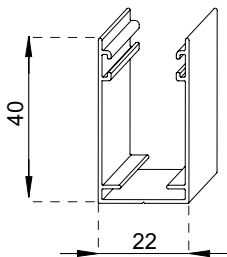

22x40

## Avvolgitori

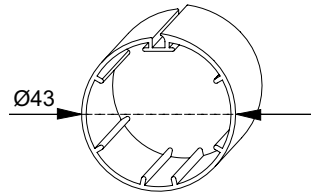

Ø 43

## TENDA A RULLO CASSONATA

**cassonetto 85x87**  
**movimentazione**  
**catena- argano - motore**

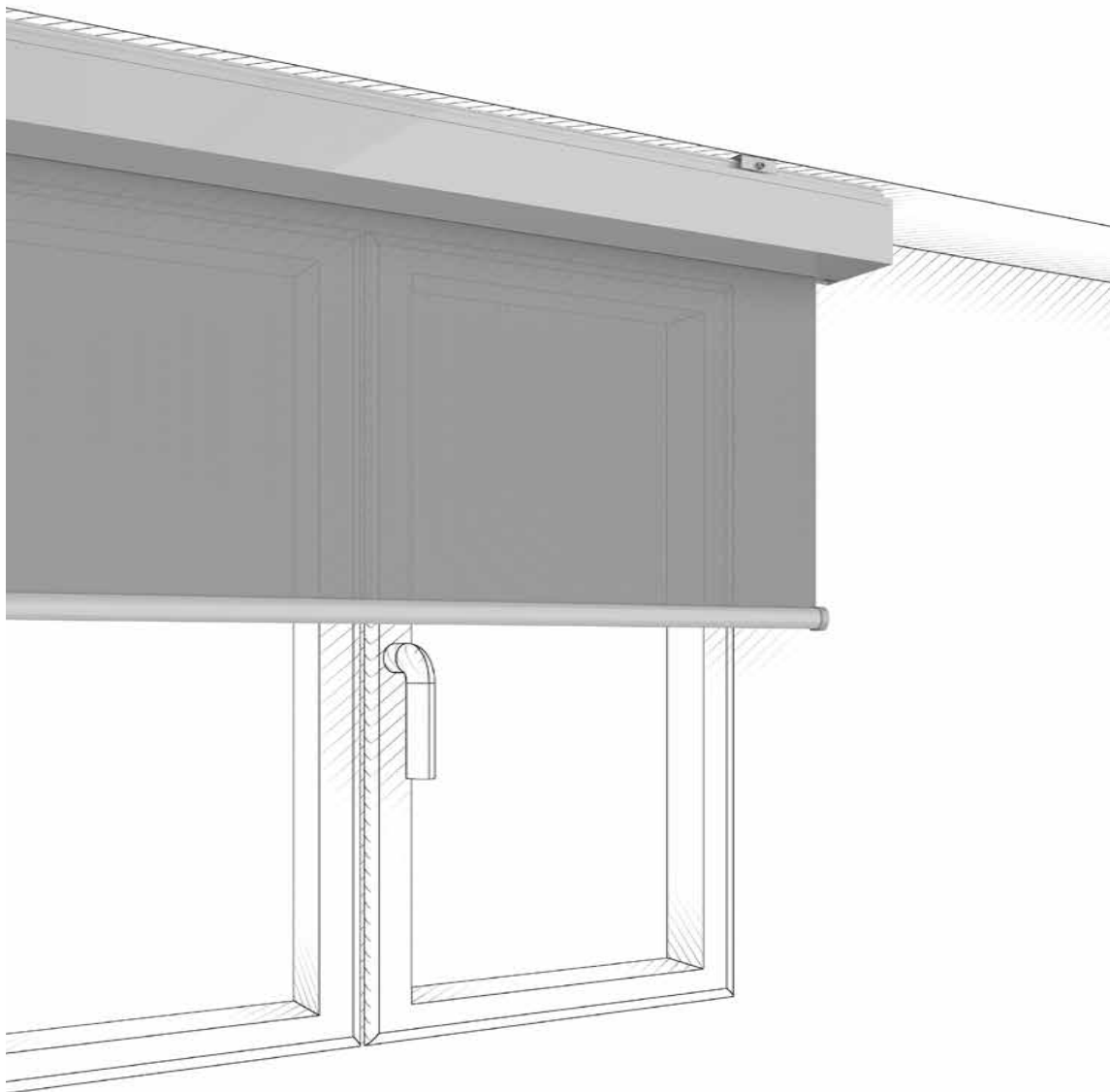

## Componenti

<b>AVVOLGITORE</b>	MATERIALE	Tubo di alluminio estruso con ogiva
<b>CASSONETTO</b>	MATERIALE	Alluminio estruso verniciato a polveri
	ISPEZIONABILE	Sì
	COMPLEMENTI	Guarnizione a spazzola
<b>FONDALE</b>	MATERIALE	Alluminio estruso verniciato a polveri
	COMPLEMENTI	Guarnizione a palloncino e zavorra in acciaio zincato
<b>GUIDE</b>	MATERIALE	Alluminio estruso verniciato a polveri
<b>VITERIA</b>	MATERIALE	Acciaio
<b>MANOVRE</b>	MOTORE	Corrente alternata AC a 230V / 14 - 16 rpm
	ARGANO	Con giunto snodato, asta e manovella snodabile
	CATENA	frizionata in plastica
<b>SUPPORTI</b>	FINITURA	Acciaio verniciato a polveri
<b>TIPI DI INSTALLAZIONE</b>		A soffitto diretto / con supporto A parete diretto / con staffa frontale
<b>INSTALLAZIONE GUIDE</b>		Frontale / In luce
<b>DIMENSIONI</b>	LARGHEZZA (mm)	700 min - 2400 max
	ALTEZZA	In funzione del telo
<b>CONFEZIONE TELO</b>	AVVOLGITORE	Cavetto con nastro
	FONDALE	Tasca con tondino

## Ingombri tecnici

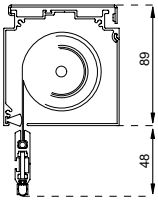

Fondale 11x41  
(rullo guidata)

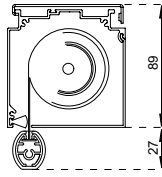

Fondale 19x23

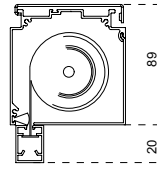

Fondale 15x20

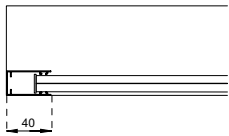

Guida 22x40

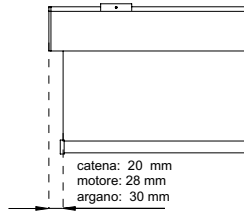

Tolleranza laterale del tessuto: motore 28mm - argano 30mm

## Modalità d'installazione

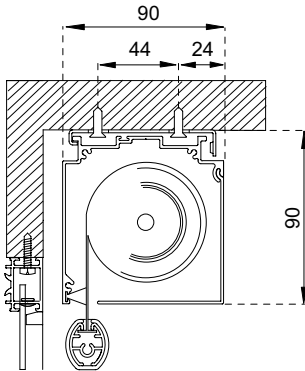

Montaggio a soffitto  
con supporto

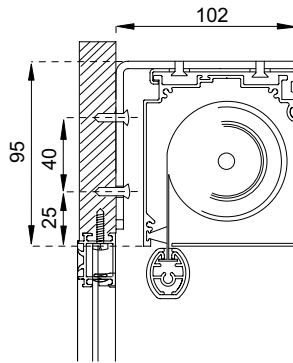

Montaggio a parete  
con staffa

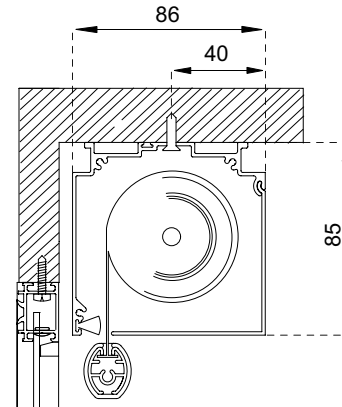

Montaggio a soffitto/parete  
diretto

## Configurazioni



Libera



Guida 22x40

## Cassonetto

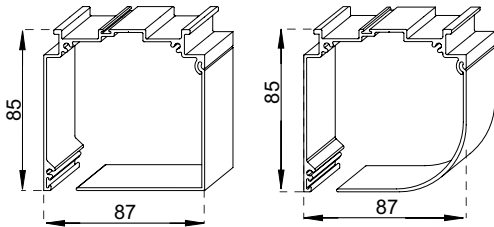

## Fondali

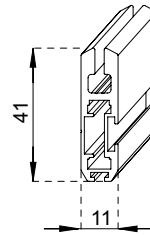

11x41  
(rullo guidata)

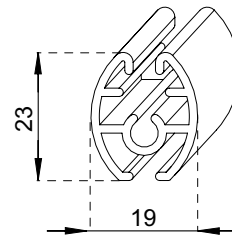

19x23

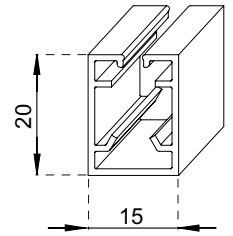

15x20

## Guide

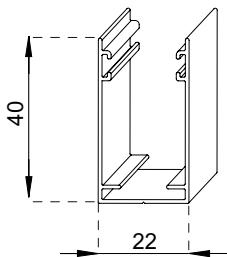

22x40

## Avvolgitori

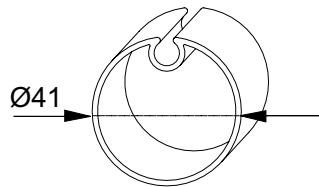

Ø 41

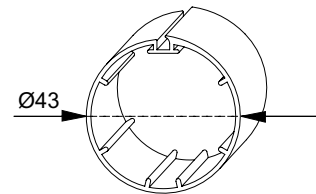

Ø 43